



Thermal Window and Door Systems



A system by
DARLEY
ALUMINIUM



ABOUT CLIMATEGUARD

ClimateGuard is a range of thermally broken framing, window and door systems, perfect for delivering optimal energy efficiency and comfort to commercial buildings. The thermal break in ClimateGuard consists of a plastic strip between interior and exterior aluminium profiles, that reduces the flow of thermal energy throughout the aluminium frame.

Designed and engineered in Australia, the ClimateGuard systems have been tested and exceeds Australian Standard AS2047. Easy to fabricate and install, ClimateGuard is also compatible with Darley's other window and door systems.

The ClimateGuard range is available in the following applications:

- Sliding / Stacking Door
- Hinge Door Inward / Outward
- Sliding Window
- Awning Window
- Casement Window
- Front Glazed Commercial Framing 100mm and 150mm
- Centre Glazed Commercial Framing 100mm and 150mm





WHAT ARE “THERMALLY BROKEN” WINDOWS AND DOORS

The *thermal break* in climateguard is created using a plastic strip that sits between the interior and exterior aluminium profiles. This strip minimises the transfer of heat and cold through the aluminium frame, creating an insulation barrier within the window or door frame and significantly improving thermal comfort and performance.

ClimateGuard window and door systems help maintain an ideal temperature in commercial buildings, thereby reducing the need for artificial heating & cooling and ultimately improving energy efficiency.

The aluminium sections used in ClimateGuard can be anodised or powdercoated to protect from harsh weather conditions including UV damage and corrosion. Speak to your local branch about the Dulux and Interpon powdercoat finishes available in each location.

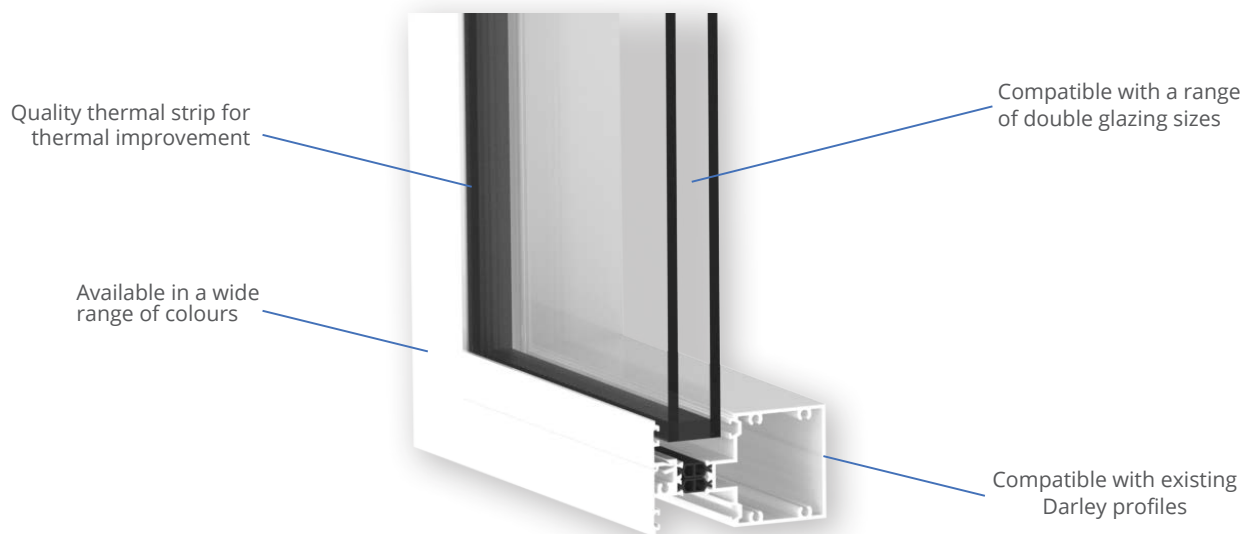

FEATURES AND BENEFITS

ClimateGuard range benefits include:

- Offers a comprehensive range including windows, doors and commercial frames
- Designed and engineered according to Australian climate conditions
- Provides optimal energy efficiency and comfort
- Easy to fabricate and install
- Reduces the need for artificial cooling & heating
- State-of-art thermal break technology
- Provides excellent thermal and acoustic insulation
- Available in a wide range of powder-coat colours
- Similar to existing Darley systems for easy transition
- IGU sizes up to 30mm - for sliding and awning/casement windows
- IGU sizes up to 34mm - for fixed framing & hinged doors

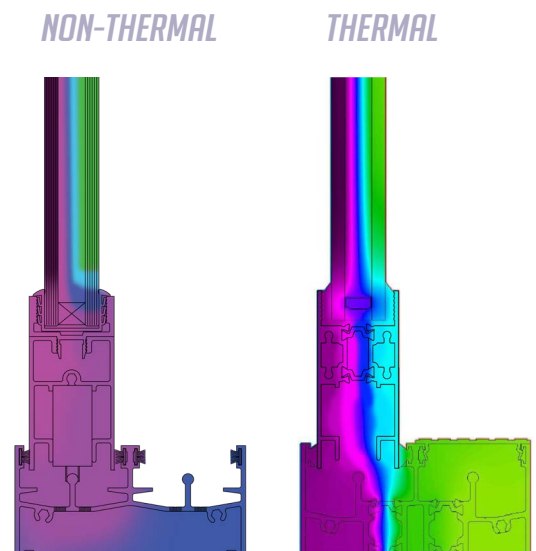



FEATURES AND BENEFITS



THE NEXT PHASE IN ENERGY EFFICIENCY

Energy efficiency is an important part of any green building project by improving insulation properties for the building envelope, as well as greater resistance to solar heat gained through a multitude of glass options. ClimateGuard window and door systems provide comfort and an energy efficient alternative to traditional aluminium windows and doors.

U-values provide a guide as to how much heat energy is transferred through a window. The lower the U-value, the better the window keeps out the hot or cold. Combined with appropriate glass selection, the window and door systems of Climateguard provide excellent insulation between the internals of a project and the outside world.



TECHNOLOGY

The technology behind the climateguard system consists of two aluminium profiles and a polyamide strip that is inserted between the aluminium exterior and interior elements creating a thermal insulator. It minimises the transfer of hot and cold through the aluminium window frame, giving the thermally broken aluminium window excellent insulation properties.



DESIGN FOR PERFORMANCE

In the future, when working with conventional framing, architects and engineers may have to alter designs or reduce and remove windows just to meet energy requirements on a project.

However, with the Climateguard range an architect can incorporate large expanses of glazing using thermally broken aluminium window systems and still comply with the new Section J energy requirements. This also allows them to maintain current trends surrounding natural light, ventilation, open spaces and great views.



TOWARDS SECTION J

It has become much harder to meet the minimum requirements for energy efficiency in commercial buildings using conventional systems. When the time comes that you need a high-performance system to get you over the line, Darley has you covered. By delivering to you an Australian designed thermally broken system, specifically designed with Australian fabricators and end users in mind, we can offer the right solution for Section J requirements.



TESTED TO THE MAX

Climateguard doors and windows are specifically designed to meet Australian climatic conditions, Australian testing standards and comply with the National Construction Code (NCC).

All Climateguard window and door systems has been tested against severe wind and water conditions, as well as air leakage and operation force. Compliance has always been important to Darley as it provides the peace of mind our customers need when using systems that need to stand the test of time.

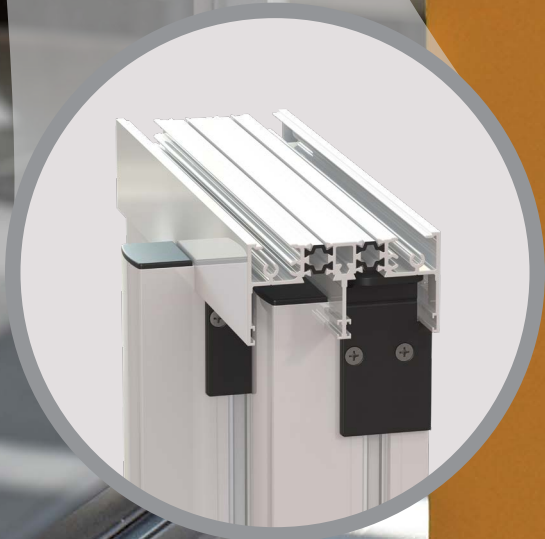

SLIDING / STACKING APARTMENT DOOR

Designed with strength and high performance in mind, this sliding door series is either used in high rise building applications or just when you require the ultimate in high performance. Its structural design allows for extra large door panels and glass thicknesses of up to 24mm can be achieved.

DESIGN FEATURES

Maximum door panel size	2700 mm x 1500 mm*
Maximum weight per door panel	160 kgs
Maximum glass thickness	24 - 30 mm

*Please refer to strength charts.

SLIDING DOOR TESTED TO AS2047 PERFORMANCE

Serviceability	1042 Pa
Ultimate	2315 Pa
Water Rating	450 Pa

SILL SIZE

Depth	100 mm
Height	62 mm (incl. sub sill)

PANEL SIZE

Height	2400
Width	1200

MAX. GLASS THICKNESS

Double Glazing	24 mm - 30 mm
----------------	---------------

STACKING DOOR TESTED TO AS2047 PERFORMANCE

Serviceability	1042 Pa
Ultimate	2315 Pa
Water Rating	450 Pa

SILL SIZE

Depth	150 mm
Height	62 mm (incl. sub sill)

PANEL SIZE

Height	2400
Width	1200

MAX. GLASS THICKNESS

Double Glazing	24 mm - 30 mm
----------------	---------------

SUPPORTED CONFIGURATIONS

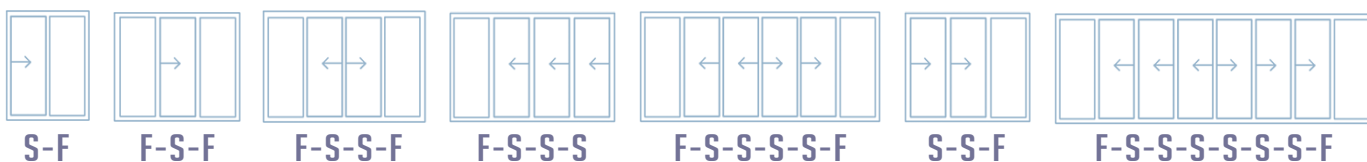

THERMAL PERFORMANCE

SLIDING DOOR

STACKING DOOR

DAR	DAR_052_05_06	DAR_052_05_12	DAR_051_05_06	DAR_051_05_12
Glass	6mm-12Ar-6mm	6mmPerformtech-12Ar-6mm	6mmClr-12Ar-6mmClr	6mmPerformtech-12Ar-6mmClr
U	3.067	2.234	3.091	2.267
SHGC	0.54	0.258	0.536	0.253

More ratings available in technical manual.



HINGED DOOR

The Climateguard 50mm water rated Hinged Door System is a market leading choice for thermally broken hinge doors, providing a well rounded solution to wind, water and energy ratings. The system provides excellent water ratings with and without subsills and is beautifully designed to minimise the number of different extrusions needed to build a door.

DESIGN FEATURES

Maximum height of 2400mm and width of 1000mm*

Accepts glass thickness from 24mm - 34mm

Compatible with a large suite of Darley mainframe options

Minimized extrusions for ease of fabrication and reduction of waste

Thermally broken system for higher performance energy values

Tested and approved by NATA accredited laboratory

* Please refer to technical manual for hinge requirements

HINGED DOOR - OPEN IN TESTED TO AS2047

PERFORMANCE

Serviceability	1800 Pa
Ultimate	3000 Pa
Water Rating	300 Pa

PANEL SIZES

Height	2400 mm
Width	1000 mm

MAX. GLASS THICKNESS

Double Glazing	24 mm - 34 mm
----------------	---------------

HINGED DOOR - OPEN OUT (WITH SUBSILL) TESTED TO AS2047

PERFORMANCE

Serviceability	2200 Pa
Ultimate	5000 Pa
Water Rating	1400 Pa

PANEL SIZES

Height	2400 mm
Width	1000 mm

MAX. GLASS THICKNESS

Double Glazing	24 mm - 34 mm
----------------	---------------

HINGED DOOR - OPEN OUT (WITHOUT SUBSILL) TESTED TO AS2047

PERFORMANCE

Serviceability	2200 Pa
Ultimate	5000 Pa
Water Rating	400 Pa

PANEL SIZES

Height	2400
Width	1000

MAX. GLASS THICKNESS

Double Glazing	24 mm - 34 mm
----------------	---------------

THERMAL PERFORMANCE

DAR	DAR_054_04_07	DAR_054_04_13
Glass	6mmClr-12Ar-6mmClr	6mmPerformtech-12Ar-6mmClr
U	3.125	2.522
SHGC	0.407	0.202

SUPPORTED CONFIGURATIONS



HD



HD



HD - HD

CLIMATEGUARD

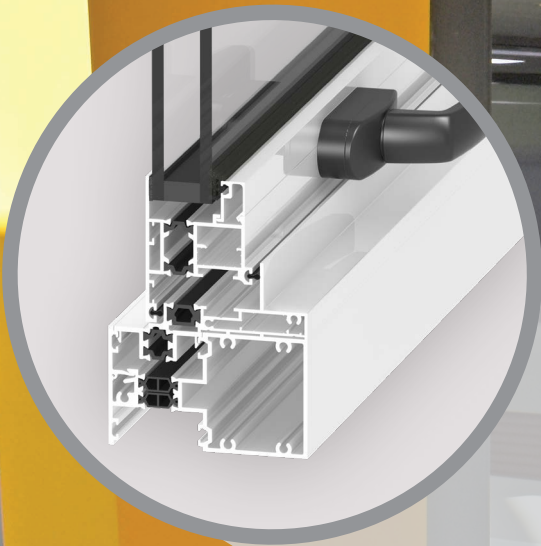

AWNING / CASEMENT WINDOW

Hinged from the top and opening outward, Climateguard Awning Windows are designed to provide continuous ventilation whilst partly opened during inclement weather. They can be positioned in a variety of places being able to stack vertically, combine horizontally or coupled with fixed panels or other windows and doors.

The design uses compression seals around the perimeter, these seals provide superior weatherproofing, saving energy, lowering noise and creating all year round comfort. Locking options are camlock or chain-winder, the chain-winder allows easy operation without interfering with insect / fly or security screens.

DESIGN FEATURES

	<i>AWNING</i>	<i>CASEMENT</i>
Maximum size per sash	2400 mm Height	700 mm Wide
Maximum weight per sash	100 kgs	45 kgs
Maximum glass thickness	24 mm - 30 mm	24 mm - 30 mm

ROTO AWNING

TESTED TO AS2047

PERFORMANCE

Serviceability	1200 Pa
Ultimate	4000 Pa
Water Rating	600 Pa

SASH SIZE

Depth	50 mm
Height	73 mm

PANEL SIZES

Height	2150
Width	1000

MAX. GLASS THICKNESS

Double Glazing	24 mm - 30 mm
----------------	---------------

ROTO CASEMENT

TESTED TO AS2047

PERFORMANCE

Serviceability	1500 Pa
Ultimate	4000 Pa
Water Rating	450 Pa

SASH SIZE

Depth	50 mm
Height	73 mm

PANEL SIZES

Height	2150
Width	950

MAX. GLASS THICKNESS

Double Glazing	24 mm - 30 mm
----------------	---------------

OPTIONS

For additional security (above first floor applications)	100 mm restricted opening
---	---------------------------

THERMAL PERFORMANCE

AWNING RECESSED STOP

CASEMENT RECESSED STOP

DAR	DAR_049_010_06	DAR_049_010_12	DAR_050_02_06	DAR_050_02_12
Glass	6mm-12Ar-6mm	6mmPerformtech-12Ar-6mm	6mm-12Ar-6mm	6mmPerformtech-12Ar-6mm
U	3.754	3.29	3.726	3.275
SHGC	0.337	0.289	0.336	0.174



FRONT / CENTRE GLAZED FRAMING

Climateguard thermally broken framing has been designed to accommodate a range of double glazed units that can achieve high performance thermal ratings for the building envelope.

Utilising high end Polyamide Thermal Break strips to achieve superior energy ratings in a system that is easy to fabricate and install in commercial and high-end residential applications.

DESIGN FEATURES

Available in 100mm and 150mm Centre and Front Glazing

All test results cover internal and external glazing beads

Captive glazing wedge option for inside or outside

Wide range of thermally broken sub-frames for both 100mm and 150mm framing installations, including two part sub heads for ease of installation

FRONT GLAZED

TESTED TO AS2047

PERFORMANCE

	100 mm	150 mm
Serviceability	1500 Pa	2000 Pa
Ultimate	3000 Pa	3000 Pa
Water Rating	600 Pa	1000 Pa

FRAME SIZE

	100 mm	150 mm
Depth	100 mm	150 mm
Height	60 mm	60 mm

MAXIMUM SIZES

	100 mm	150 mm
Height	2400 mm	2700 mm
Width	1200 mm	1500 mm

MAX. GLASS THICKNESS

	100 mm	150 mm
Double Glazing	24 mm - 34 mm	24 mm - 34 mm

CENTRE GLAZED

TESTED TO AS2047

PERFORMANCE

	100 mm	150 mm
Serviceability	1500 Pa	2500 Pa
Ultimate	3000 Pa	4000 Pa
Water Rating	600 Pa	1200 Pa

FRAME SIZE

	100 mm	150 mm
Depth	100 mm	150 mm
Height	60 mm	60 mm

MAXIMUM SIZES

	100 mm	150 mm
Height	2400 mm	2700 mm
Width	1200 mm	1500 mm

MAX. GLASS THICKNESS

	100 mm	150 mm
Double Glazing	24 mm - 34 mm	24 mm - 34 mm

THERMAL PERFORMANCE

FRONT GLAZED FRAMING

DAR	DAR_053_014_06	DAR_053_014_12
Glass	6mmClr-12Ar-6mmClr	6mmPerformtech-12Ar-6mmClr
U	2.905	1.933
SHGC	0.629	0.297

CENTRE GLAZED FRAMING

DAR	DAR_054_014_06	DAR_054_014_12
Glass	6mm-12Ar-6mm	6mmPerformtech-12Ar-6mm
U	2.889	1.913
SHGC	0.625	0.294



TESTED TO AS2047



Under the Building Code of Australia, we are required to produce windows and doors that meet mandatory minimum specifications under Australian Standard (AS) 2047 – including AS1288.

SIMULATIONS OF HIGH WINDS AND DRIVING RAINS

AS4420.2 Deflection Test - positive and negative wind pressures are applied to the face of the window to test the maximum deflection under wind load.

AS4420.5 Water Penetration Resistance Test - to verify that no water leaks through the window into the building.

OPERATING FORCE REQUIREMENT

AS4420.3 Operating Force Test – to verify that an opening sash is capable of opening and closing without undue effort.

AIR INFILTRATION PRESSURE

AS4220.4 Air In filtration Test – the air leakage of a window is tested to ensure energy and acoustic efficiency.

ULTIMATE STRENGTH TESTING

AS4420.6 Ultimate Strength Test – negative and positive wind pressures are applied to the window to at least 1.5 times the design wind pressure to ensure it does not fail in unusual wind conditions.





HOW CLIMATEGUARD COMPLIES

WITH THE RECENT CHANGES TO THE NATIONAL CONSTRUCTION CODE

The NCC provides the minimum necessary requirements for safety, health, amenity and sustainability in the design and construction of new buildings (and new building work in existing buildings) throughout Australia. *The National Construction Code changes will commence 1st May 2019.*



Australian Government

SOME OF KEY CHANGES TO THE CODE WILL INCLUDE:

ENERGY EFFICIENCY

The commercial building energy efficiency provisions have undergone their first major overhaul since 2010, consistent with the COAG National Energy Productivity Plan. A package of measures for Volume One focuses on reducing energy consumption by a potential 35%, representing a step-change for commercial buildings.

The commercial building energy efficiency requirements (i.e. Section J) are significantly changed, including new VMs for NABERS and Green Star. This change is subject to a 1 year transition period from 1 May 2019, during which time, either the NCC 2016 or NCC 2019 requirements may be used.



HARDWARE PROFILES



ROTO

Roto Frank AG is a global leader in window and door hardware. Established in 1935, they developed Roto Tilt & Turn hardware, the first industrially produced hardware which offered turning and tilting capabilities for windows.

Together with the profile system, window handles are the most important stylistic element of a window. Roto offer a wide selection of handles in a variety of styles and colours, in both classic and modern designs. Roto window handles are also long lasting and certified in accordance with RAL standards.

The Roto handle range includes:

- Roto Swing
- Roto Line
- Roto Samba
- Roto Freestyle



BRIO

Brio is passionate about shaping the spaces in which people live, work and play producing cutting edge screen solutions, tracks and hardware kits for sliding & folding door systems in both interior & exterior, residential or commercial spaces.

Brio specialise in:

- Door Hardware
- Sliding Door Hardware
- Folding Door Hardware



AUSTRAL

Austral has a reputation for reliability in premium security hardware for both doors and windows.

Australian-owned and operated, Austral Lock products are designed and made in Australia providing complete control over process and quality of products. Austral Lock products are Australian made premium quality and include: Security Door Locks, Patio Door Locks, Window Locks, Multi Point Kits and accessories.



LOCK UP WITH LOCKWOOD®

LOCKWOOD

Lockwood is the leading brand in the Australian locking industry. With a well-established reputation for high quality products, this iconic brand provides a wide range of locking solutions to residential housing, commercial building and industrial application markets, supported by an extensive distribution and after-sales support network.

Their range of door handles include:

- Rose Door Handles
- Plate Door Handles
- Push/Pull Door Handles



DORMAKABA

No matter where you need innovative, reliable access and security solutions, DormaKaba are there to provide high-quality access and security products for the hospitality, retail and medical industries.

In 2016 Dorma Australia join forces with Kaba Australia to form Dormakaba Australia.

Dormakaba provides single components as well as customised integrated solutions covering door hardware, entrance systems, electronic access & data, master key systems, lodging systems, safe locks, interior glass systems, operable walls and service division.



100MM CENTRE SLIM

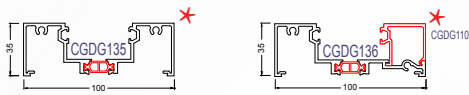

SUBFRAMING

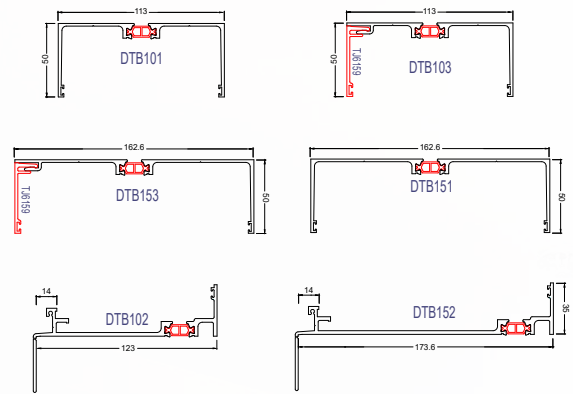

100MM CENTRE GLAZED

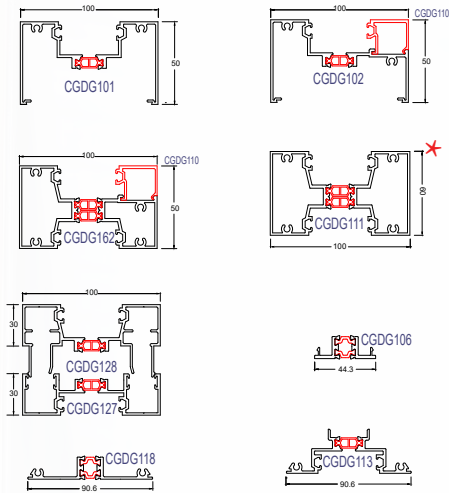

150MM FRONT GLAZED

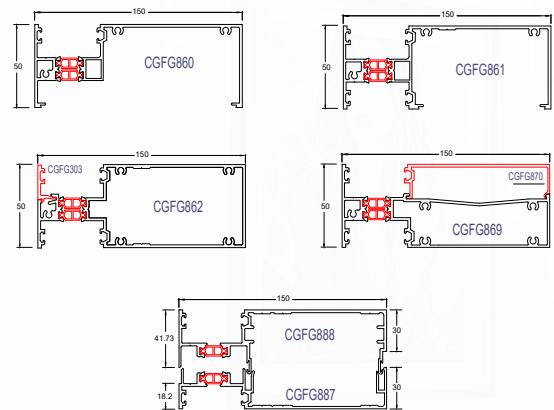

100MM FRONT GLAZED

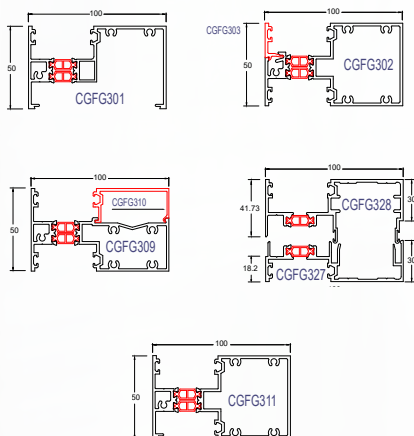

150MM CENTRE GLAZED

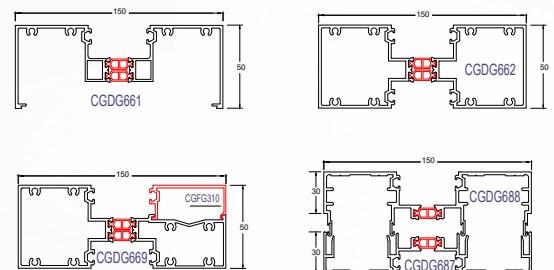

AWNING / CASEMENT WINDOW

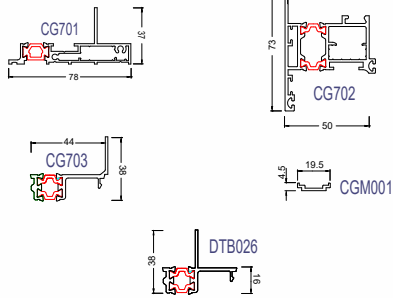

HINGED DOOR

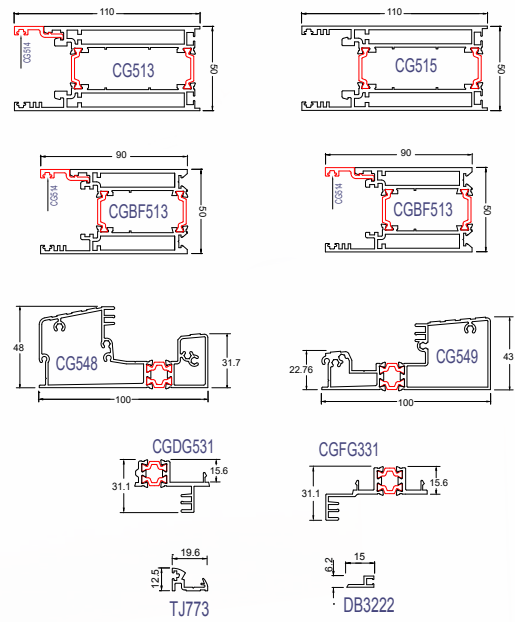

APARTMENT DOOR / SLIDING WINDOW

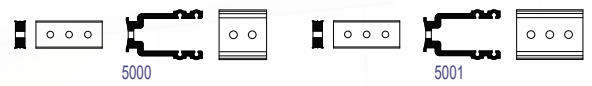
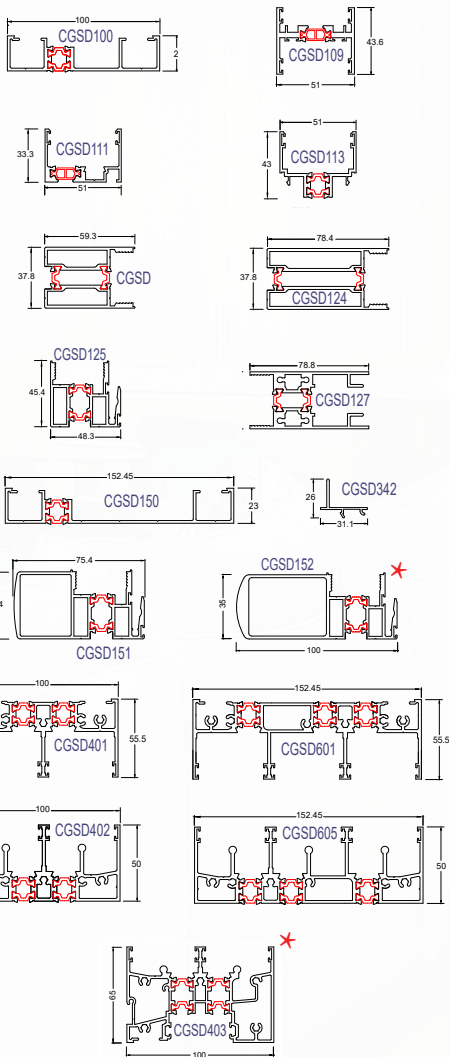

MULTI-FOLD DOOR

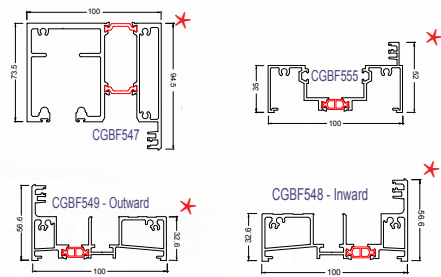

MISCELLANEOUS

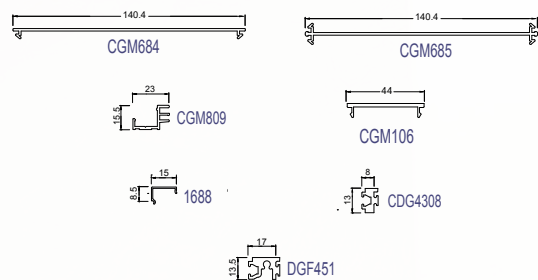



SYDNEY HEAD OFFICE

8 Tyrone Place, Erskine Park NSW 2759
Tel: (02) 8887 2888
Fax: (02) 9834 3244
Email: sales@darleyaluminium.com.au

MELBOURNE

10 Bridge Road, Keysborough VIC 3173
Tel: (03) 9238 3888
Fax: (03) 9768 7288
Email: salesvic@darleyaluminium.com.au

BRISBANE

29 Access Avenue, Yatala QLD 4207
Tel: (07) 3287 1888
Fax: (07) 3287 2088
Email: salesqld@darleyaluminium.com.au

PERTH

36 Armstrong Road, Hope Valley WA 6165
Tel: (08) 9437 2999
Fax: (08) 9437 1024
Email: saleswa@darleyaluminium.com.au

